

COVA
601.04 | 40" Round

These drawings have not been reviewed and approved by the architect and cannot ever be used for construction purposes. These drawings are for the exclusive use of Lumicor. Any use of these drawings by others will be at their own risk and lumicor will not be responsible for issues that may arise from their use.

© Lumicor 2019 — All Rights Reserved. For more information, visit www.lumicor.com or call 1.888.LUMICOR (888.586.4267)

Patent Pending

Solution
601.04

12/30/19

Page 1 of 3

BLADE LAYOUT

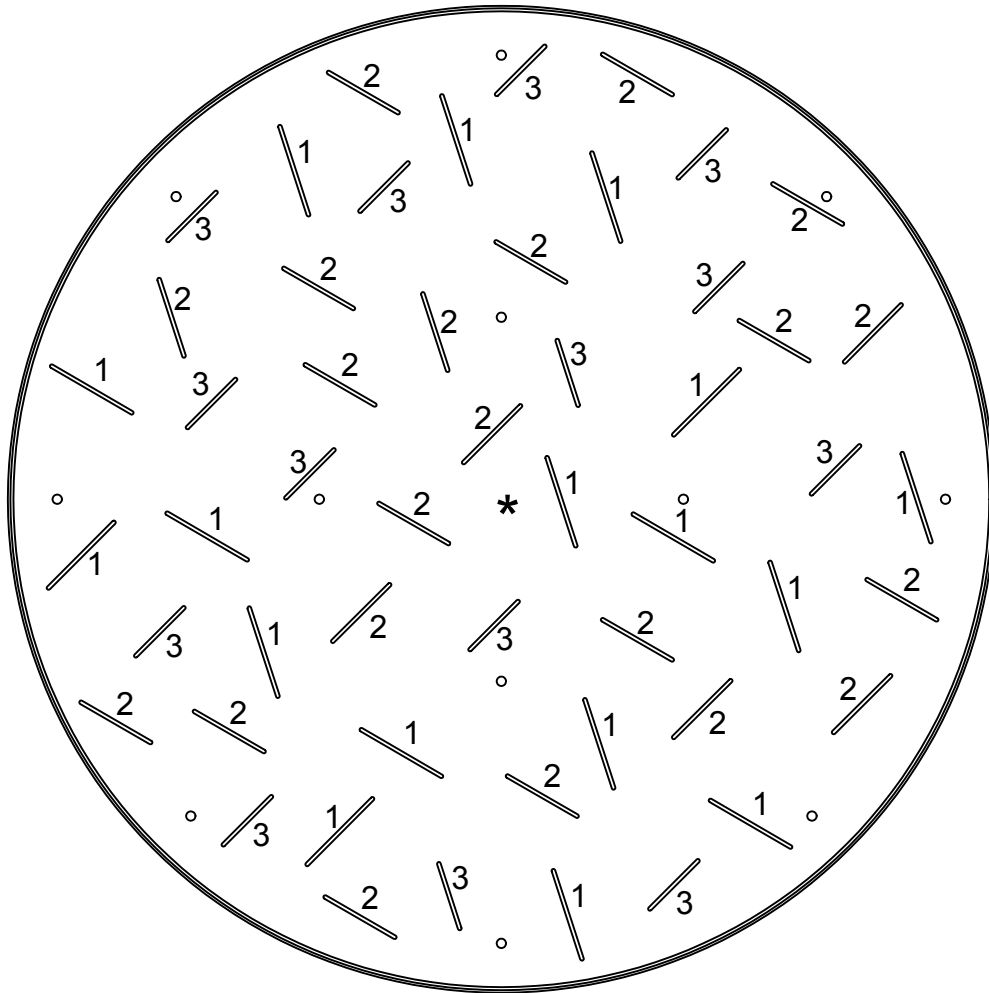

BLADE DETAIL

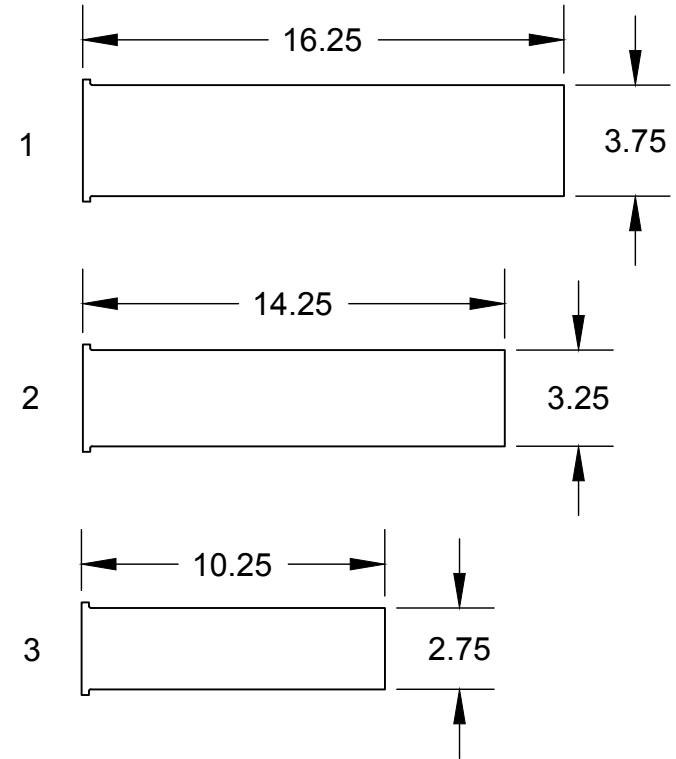

*INDICATES WIRE EXIT LOCATION FOR PLACEMENT OF CUSTOMER PROVIDED ENCLOSURE

PARTS LIST

ITEM NUMBER	ITEM DESCRIPTION	QTY PER FIXTURE
1	ANCHOR	12
2	LUMILIGHT PANEL	1
3	LUMICOR SKIRT	1
4	STANDOFF	12
5	COVA LID	1
6	STANDOFF CAP	12
7	COVA BLADE 1	16
8	COVA BLADE 2	21
9	COVA BLADE 3	14
10	SKIRT CONNECTION	1
11	DOC. COVA INSTALL INSTRUCTIONS	1
12	DOC. LUMILIGHT WIRE DIAGRAM	1
13	DOC. COVA 601.04 DRAWINGS	1

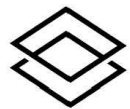
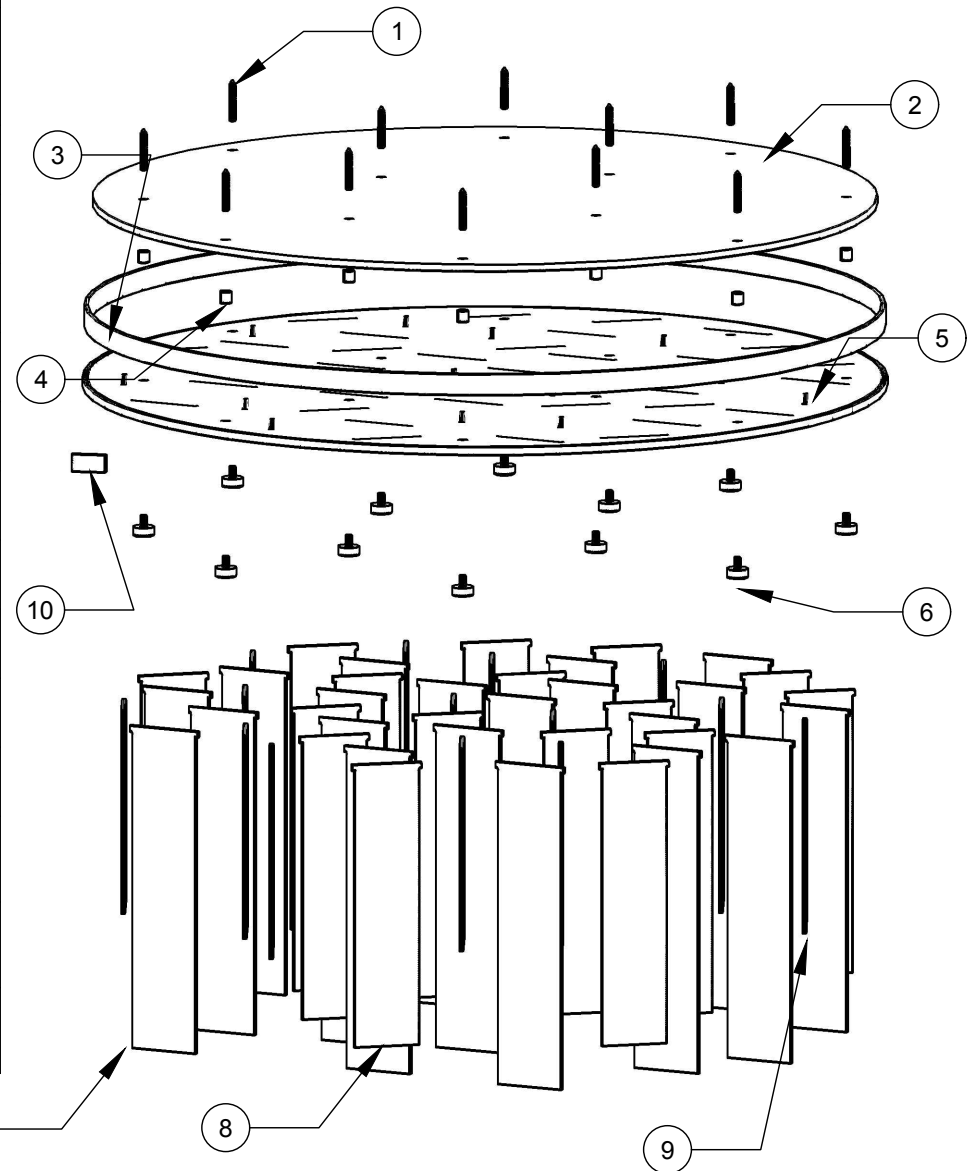

Lumicor.

COVA 601.04 | 40" Round

These drawings have not been reviewed and approved by the architect and cannot ever be used for construction purposes. These drawings are for the exclusive use of Lumicor. Any use of these drawings by others will be at their own risk and lumicor will not be responsible for issues that may arise from their use.

© Lumicor 2019 — All Rights Reserved. For more information, visit www.lumicor.com or call 1.888.LUMICOR (888.586.4267)

Patent Pending

Solution
601.04

12/30/19

Page 3 of 3