

Lumicor.

LOW PROFILE SUSPENDED WALL

102.02 | .472 Single Section

These drawings have not been reviewed and approved by the architect and cannot ever be used for construction purposes. These drawings are for the exclusive use of Lumicor. Any use of these drawings by others will be at their own risk and lumicor will not be responsible for issues that may arise from their use.

© Lumicor 2019 — All Rights Reserved. For more information, visit www.lumicor.com or call 1.888.LUMICOR (888.586.4267)

Solution
102.02

10/8/19

Page 1 of 3

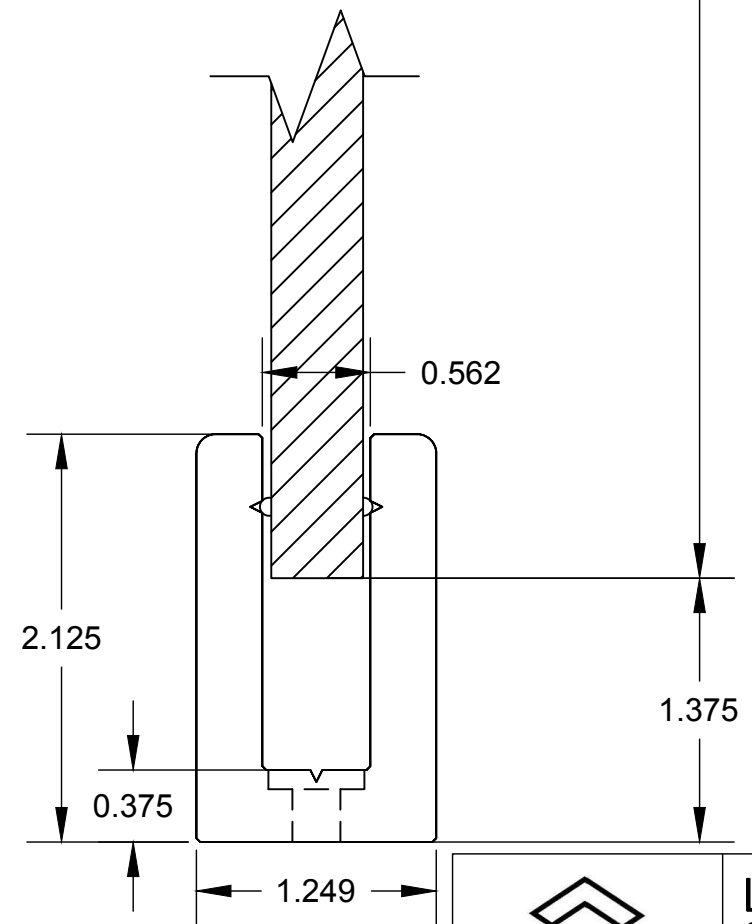
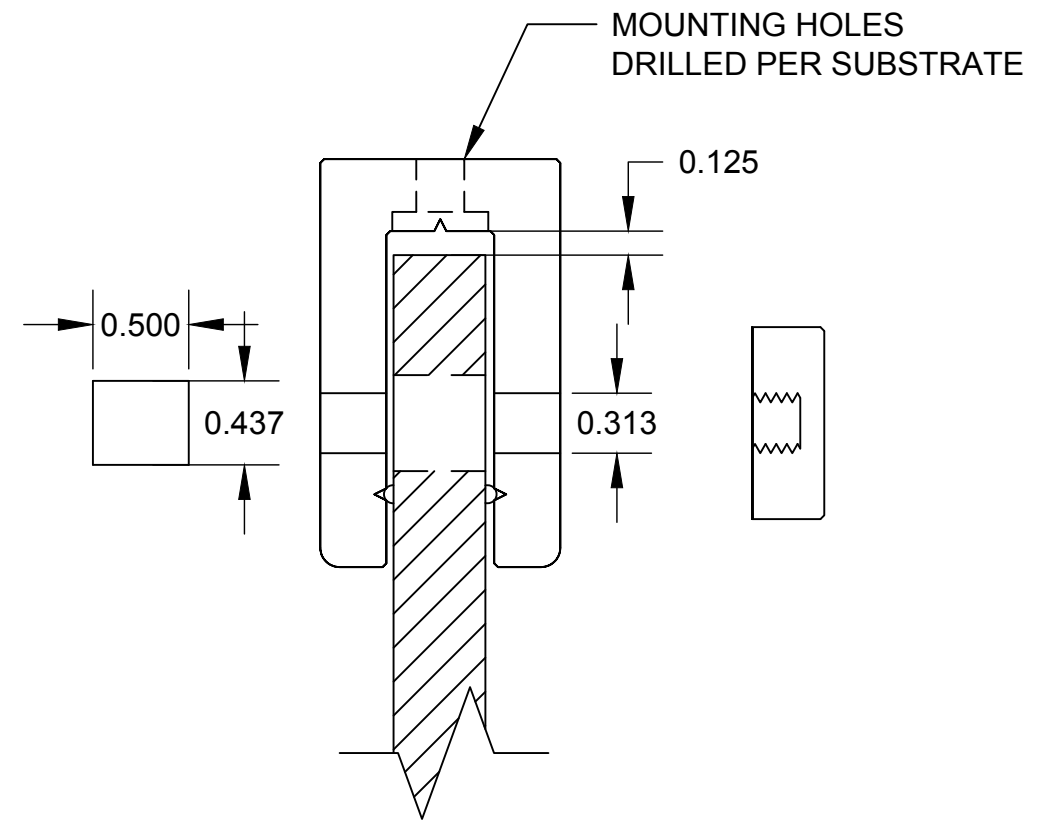
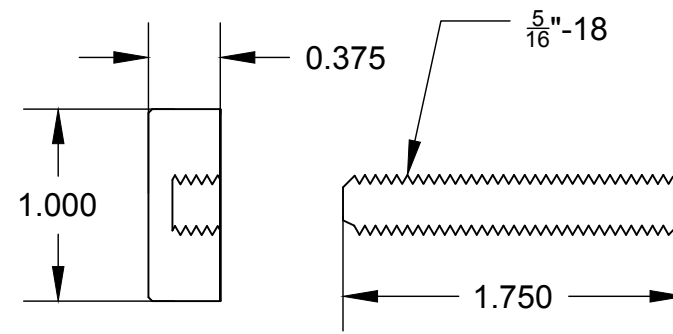
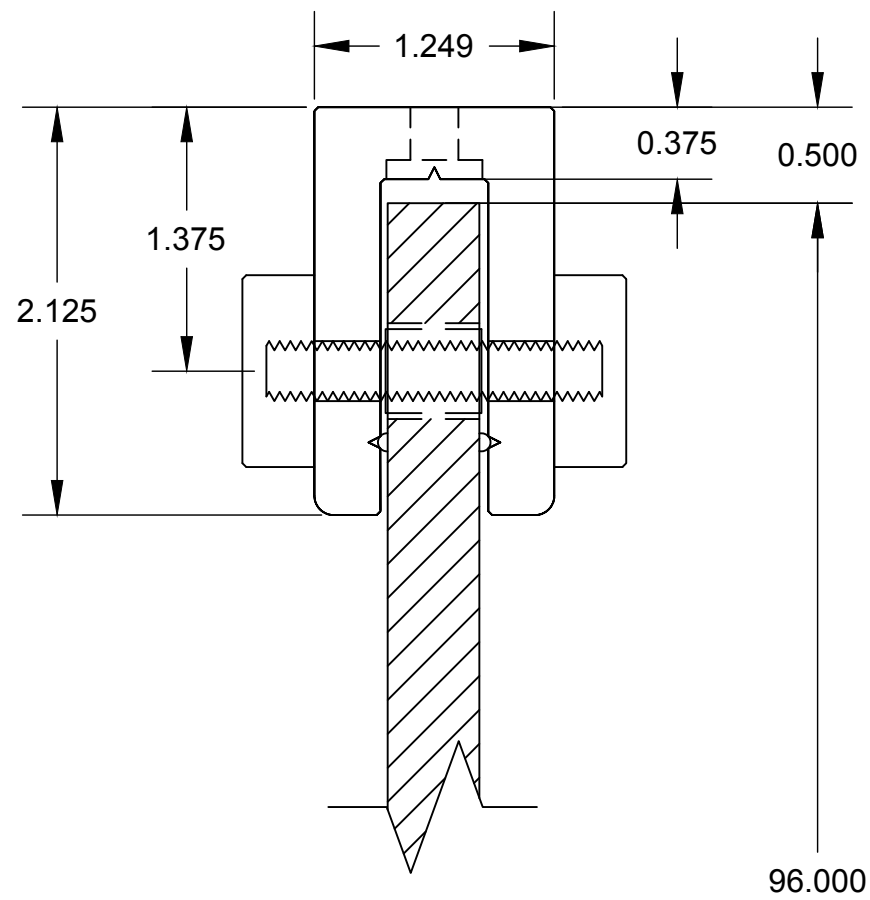

SECTION VIEW (A)

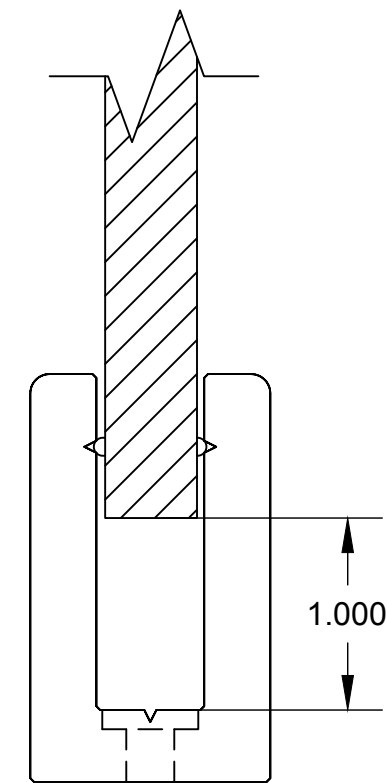

LOW PROFILE SUSPENDED WALL
102.02 | .472 Single Section

These drawings have not been reviewed and approved by the architect and cannot ever be used for construction purposes. These drawings are for the exclusive use of Lumicor. Any use of these drawings by others will be at their own risk and lumicor will not be responsible for issues that may arise from their use.

© Lumicor 2019 — All Rights Reserved. For more information, visit www.lumicor.com or call 1.888.LUMICOR (888.586.4267)

Solution
102.02

10/8/19

Page 2 of 3

PARTS LIST

ITEM NUMBER	QTY PER CONFIG	PART DESCRIPTION
1	3	SET SCREW
2	4	END CAP
3	3	TUBING
4	8	ANCHOR SCREW
5	6	CAP
6	2	C TRACK
7	2	CORD GASKET

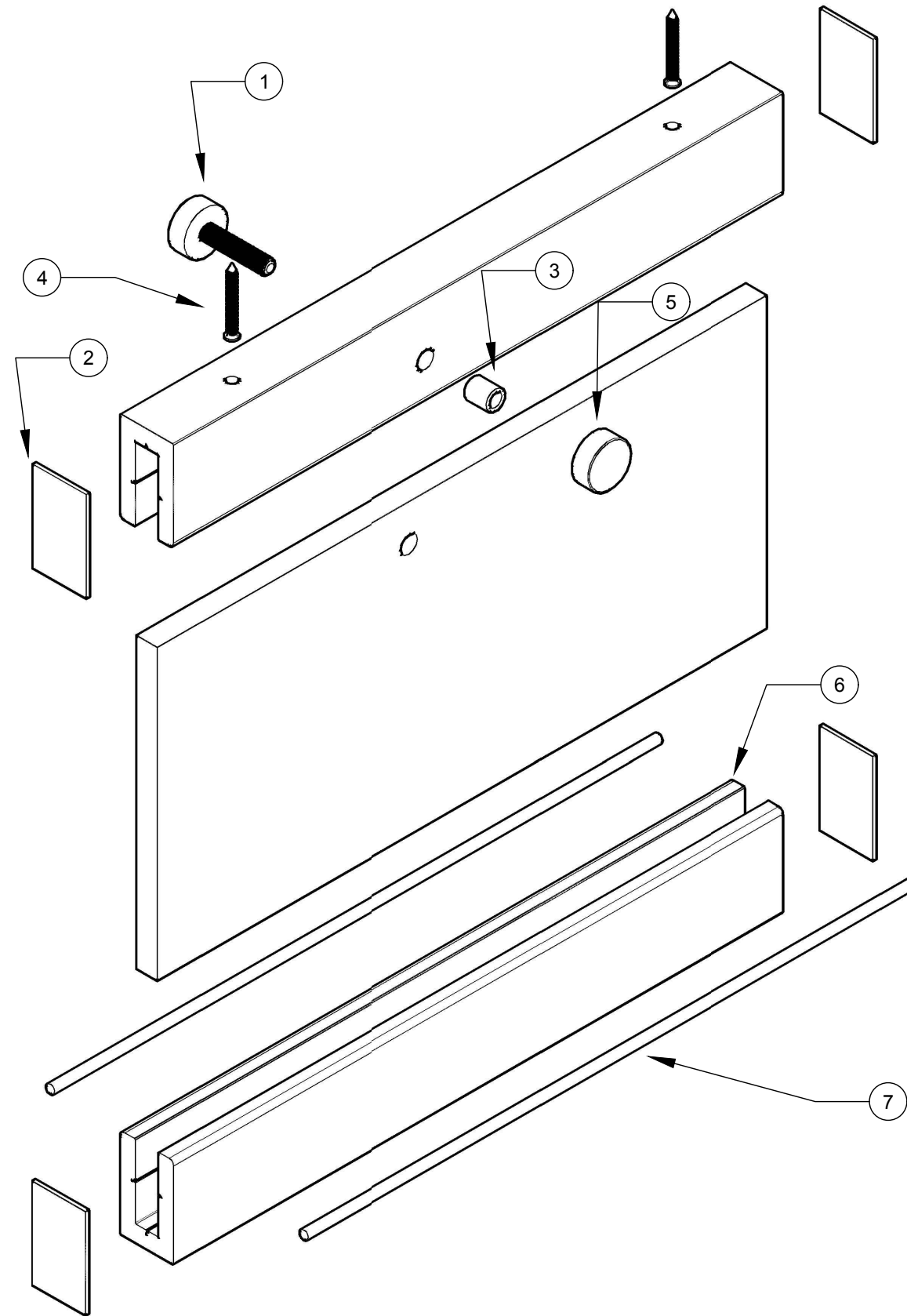

LOW PROFILE SUSPENDED WALL

102.02 | .472 Single Section

These drawings have not been reviewed and approved by the architect and cannot ever be used for construction purposes. These drawings are for the exclusive use of Lumicor. Any use of these drawings by others will be at their own risk and lumicor will not be responsible for issues that may arise from their use.

© Lumicor 2019 — All Rights Reserved. For more information, visit www.lumicor.com or call 1.888.LUMICOR (888.586.4267)

Solution
102.02

10/8/19

Page 3 of 3